

XFY10 Miniature Pentode SPICE Macro Model

Transfer Characteristics

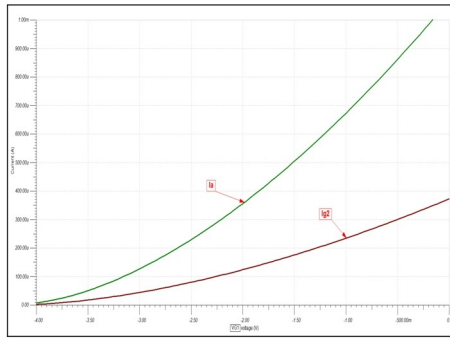

Output Characteristics

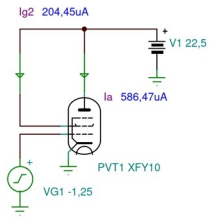
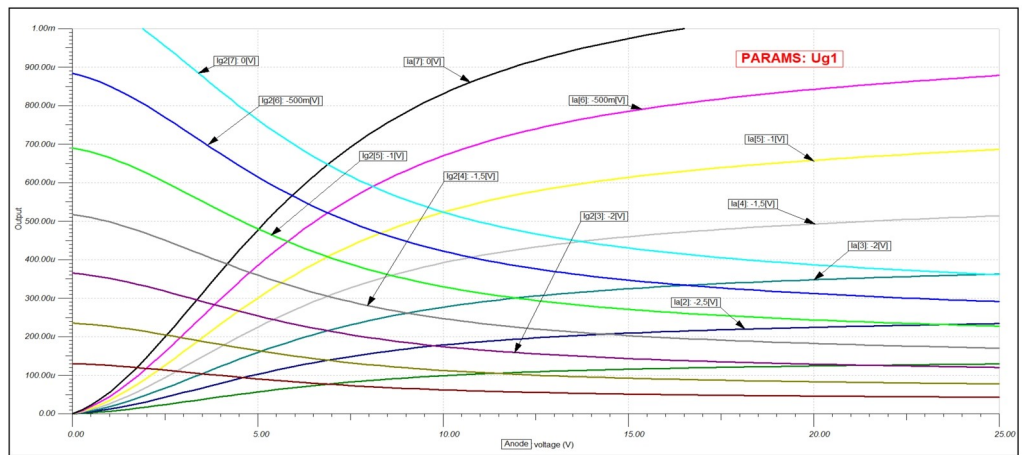
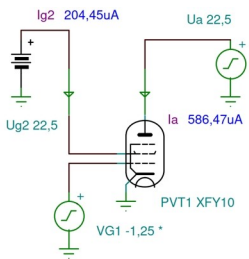

Audio Amplifier (Model)

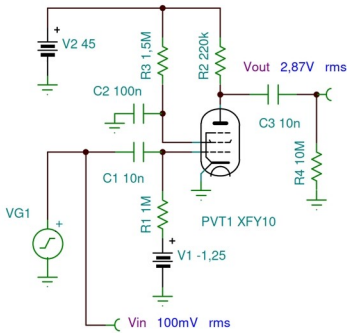

Model $A_v = 28.7x$

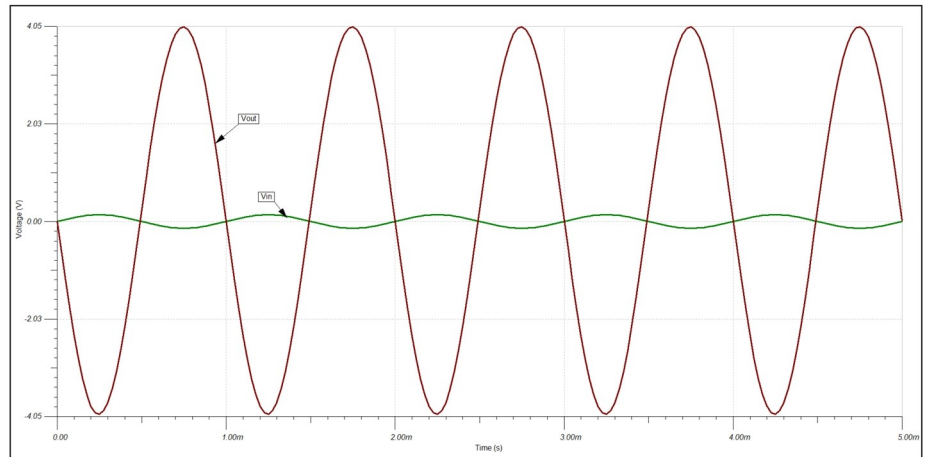

Audio Amplifier (Real Tube)

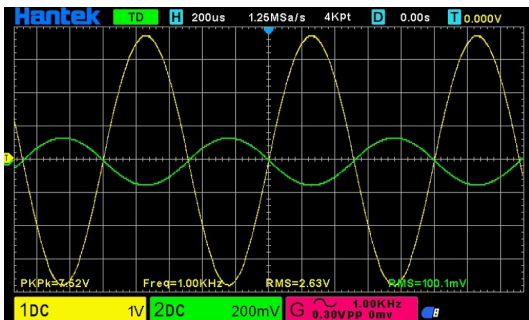

$A_v = 26.3x$

The model provides good accuracy for both DC operating points and AC gain.

Zabb Csaba