

DAC08 8-Bit, High Speed, Multiplying D/A Converter Macro Model

Basic Bipolar Output Operation

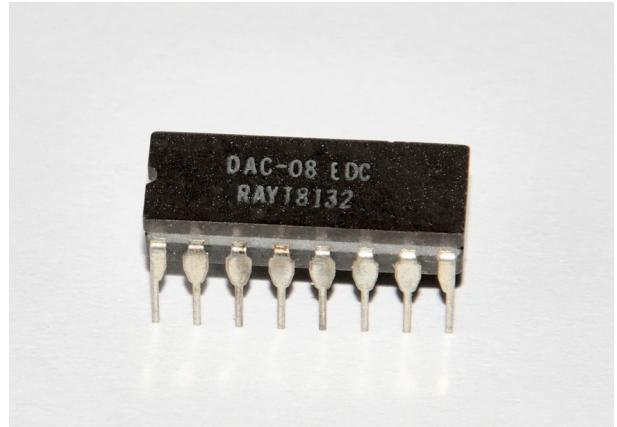

Positive Low Impedance Output Operation

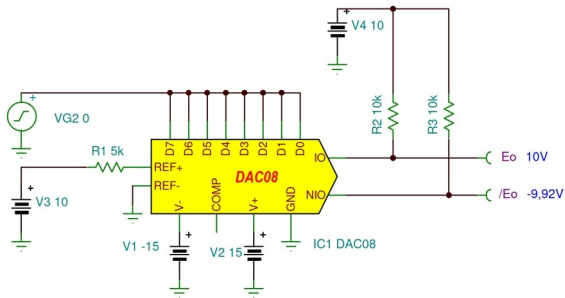
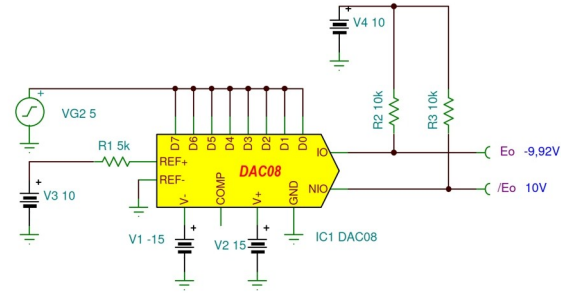
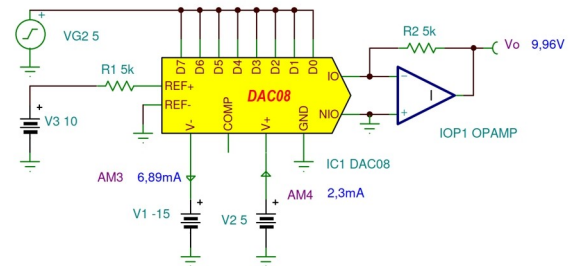
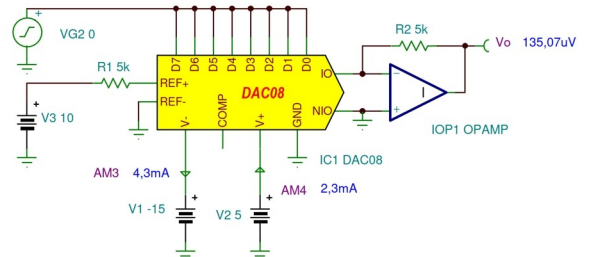

Basic Unipolar Negative Operation

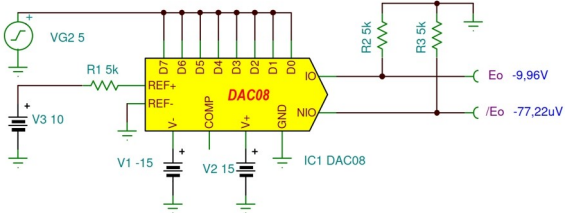
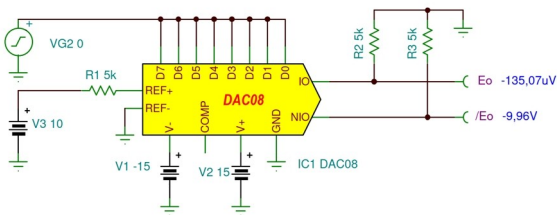

Linear Ramp Generator

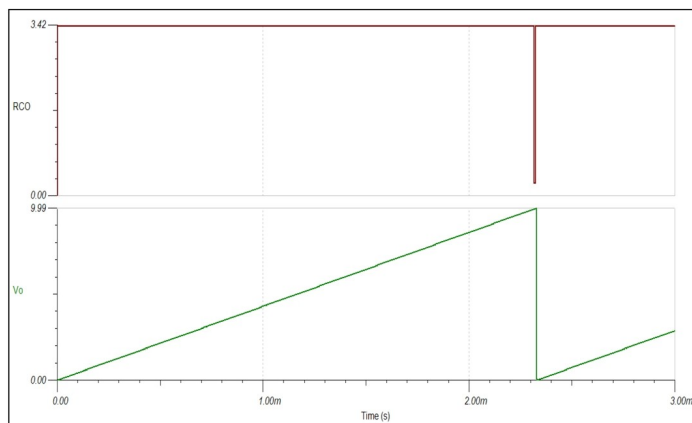
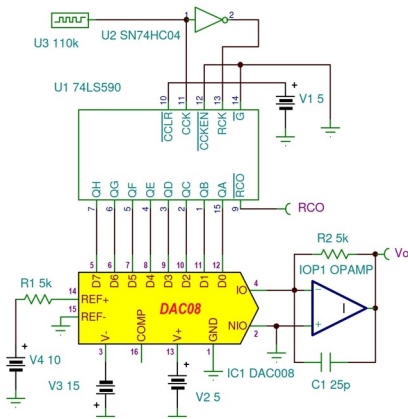

Zabb Csaba