

EBF89 /Tungsram, Hungary/ Double Diode-Pentode Macro Model

Pentode DC Characteristics

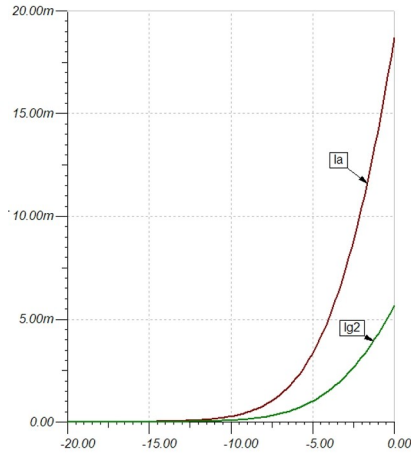

Output Characteristics

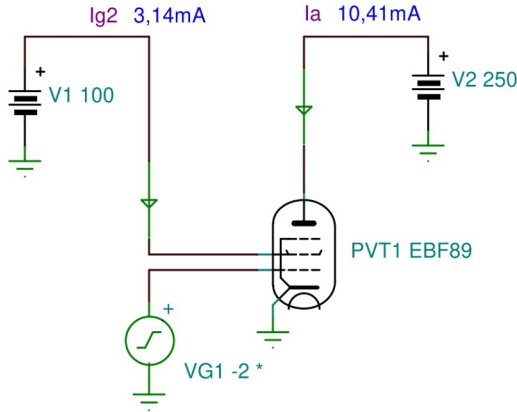
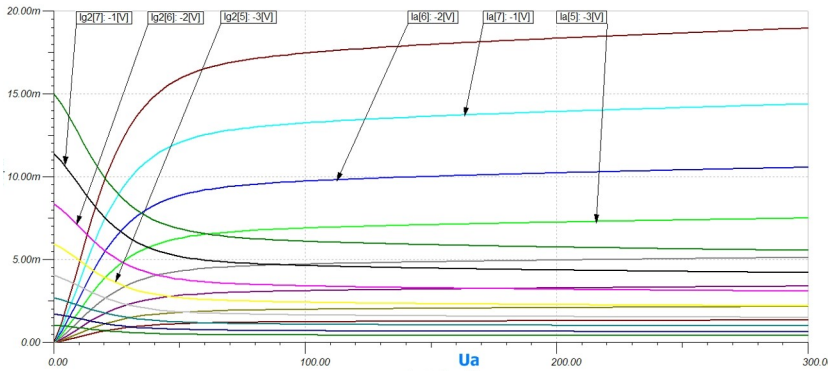

This model is valid for the following tubes (within max. ratings):
6DC8, 6FD12, 7125

$I_{g1} = f(U_{g2})$

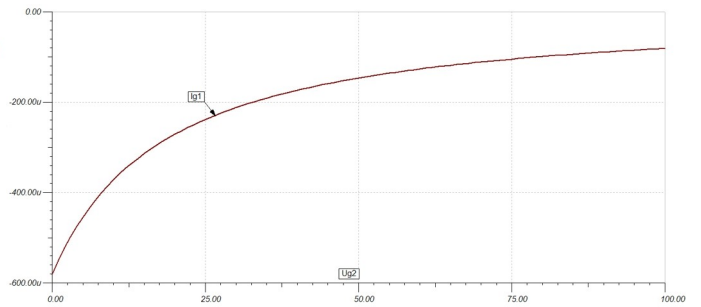
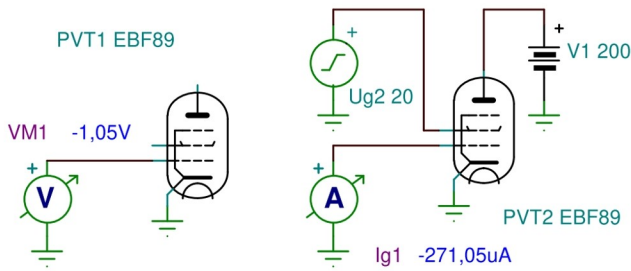

Diode Splash Current

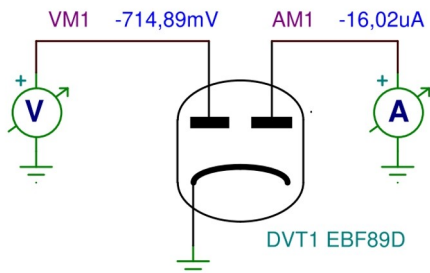

Diode Forward Characteristics

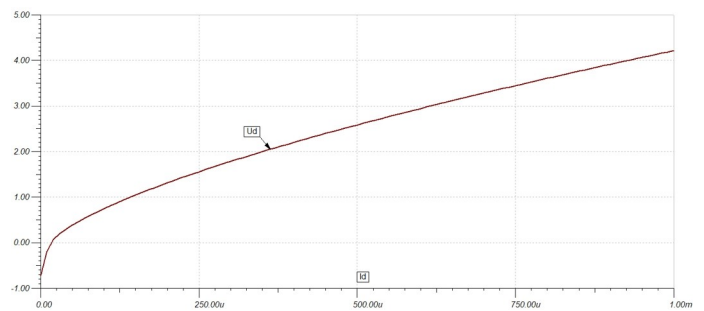

Pentode Operating Characteristics

