

14TA31 Miniature Voltage-regulator Tube Macro Model

DC Characteristics:

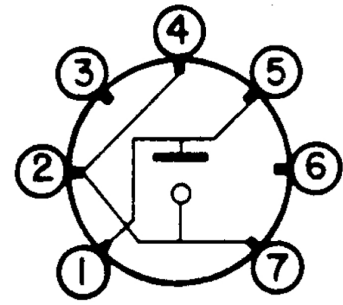

BOTTOM VIEW

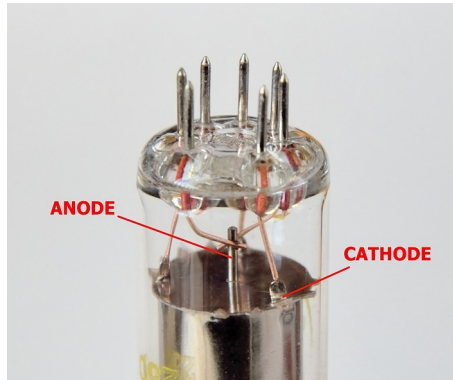
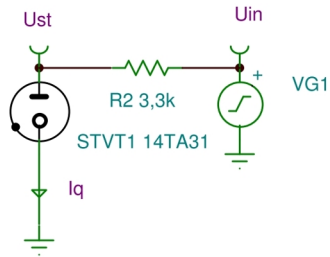
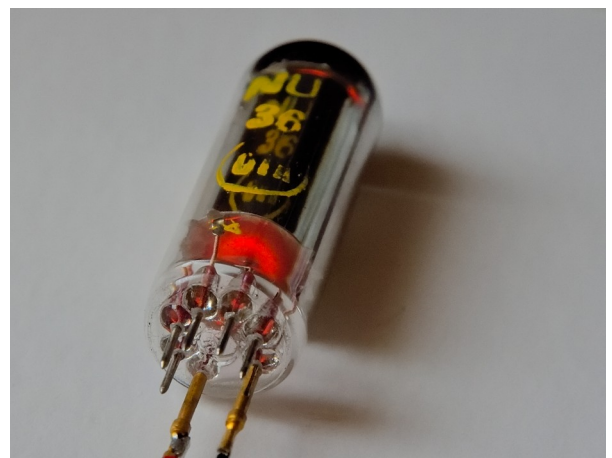
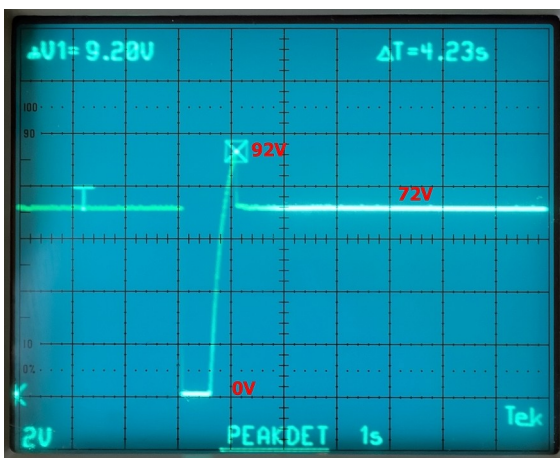
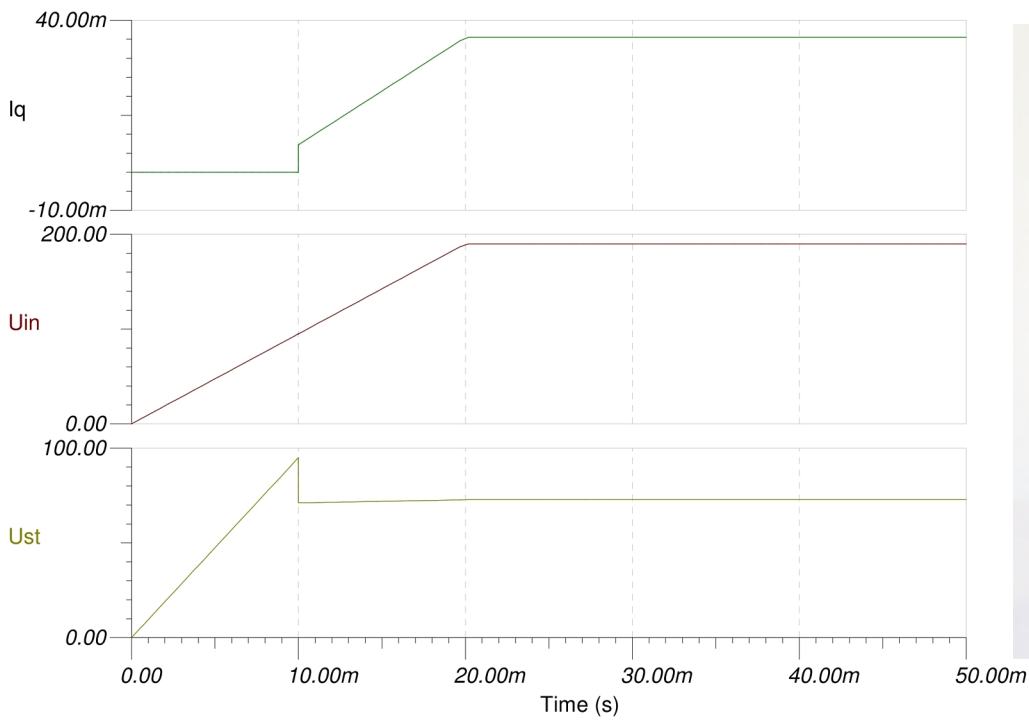

Regulation:

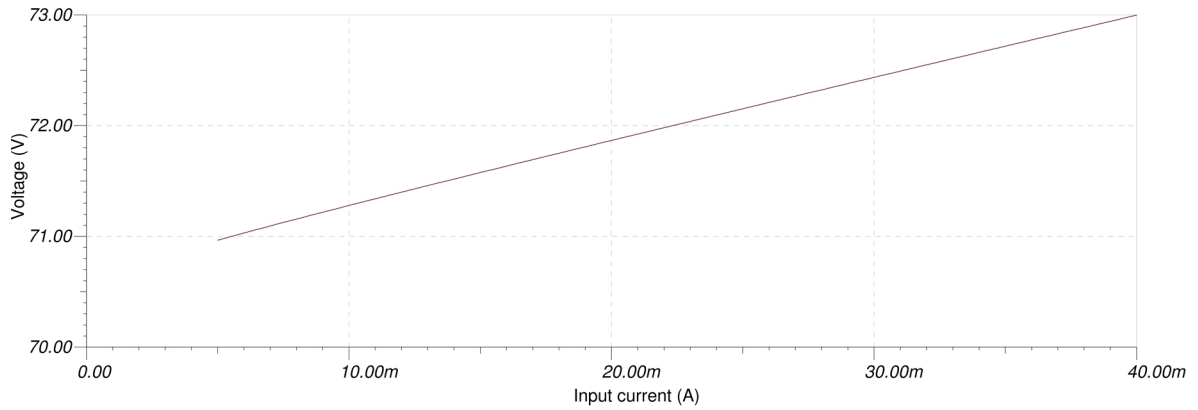

Shunt Capacitor:

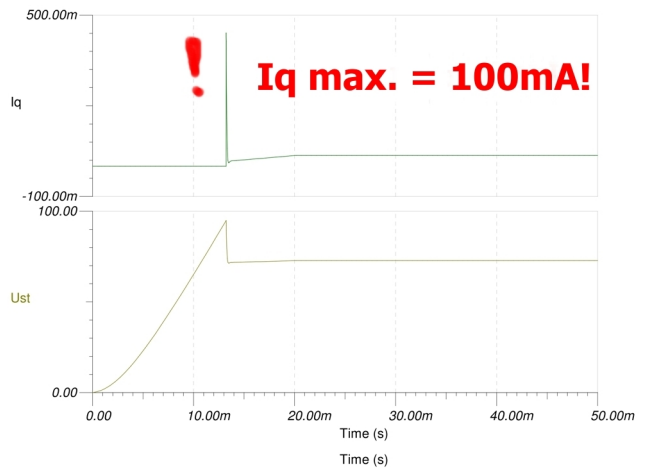
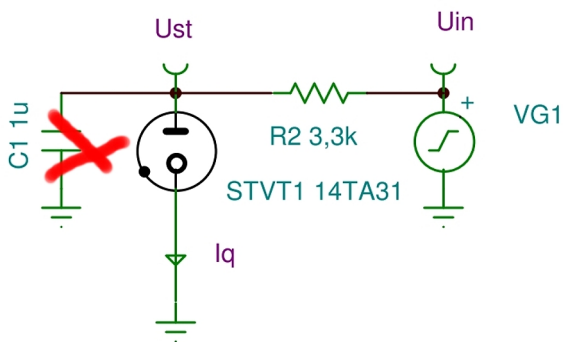

Don't connect a greater capacitor ($C_{max}=100nF$) without a current limiting resistor parallel to the regulator tube!

Relaxation Oscillator:

